

VIA WALKWAY LIGHT 230V

Installation manual

basalte

Safety instructions

Before installing the unit, read this manual thoroughly and retain it for future reference.

The device should be installed in compliance with official regulations valid in country of use.

The device may only be installed and connected by qualified electricians.



Make sure that the wire to the earth is connected to the Via.

The front cover should always be mounted before powering the device.

Ensure that electricity is switched off when installing or unmounting the device.

Do not open, dismantle, alter or modify the device.

Components

model nr: 0480-11 (cold white) | 0480-12 (warm white)

Via walkway light front

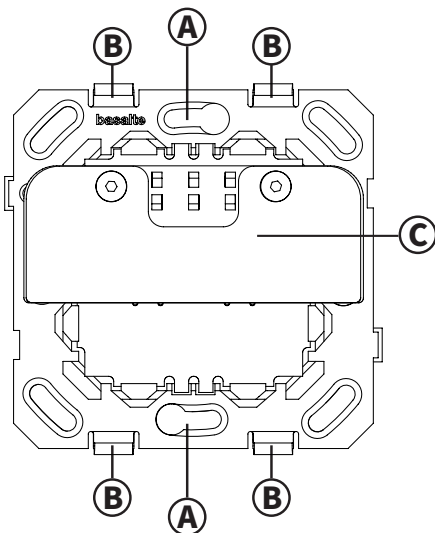

- A Opening to fix the outlet to the wall box
- B Clips to mount the cover plate
- C LED-strip

Via walkway light back

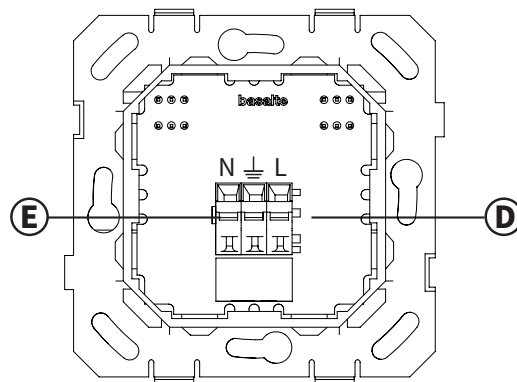

- D 230V connections
- E Use a flathead screwdriver to open the wire terminals

Wall boxes

The Via should be installed in European wall boxes with screws. The distance between the screws needs to be 60 mm, and a minimal depth of 45 mm is required.

Square wall boxes size 60 x 60 mm are compatible with the Via.

The following round wall boxes are compatible with the Basalte Via:

- Helia round with cut hole 68 mm (type 247, 261).
- Kaiser round with cut hole 68 mm (type 9063-xx, 9064-xx, 9062-xx).
- Legrand batibox round (ref 080051, 080061, 080052, 080053).
- ABB round Hafobox MD4050 and hollow wall boxes HW-50, HW50-G, HW52-F (except HW52-F IGD and HW52-F BW).



When using other round boxes, please verify the compatibility upfront.

Do not use following wall boxes:

- Helia O-range
- Kaiser (1055-xx – 1056-xx)
- ABB 3040
- ABB HW52-F IGD and HW52-F BW

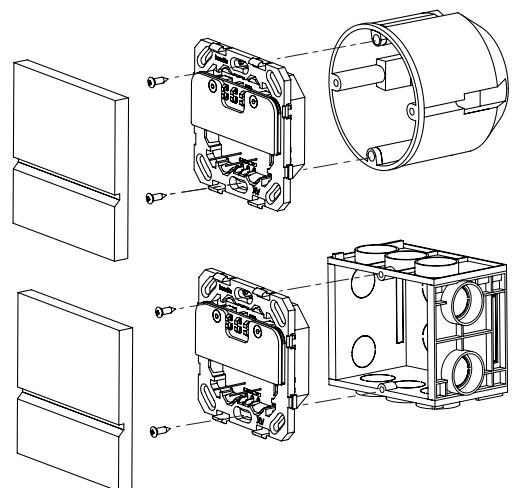

Via cover
0481-xx (not included)

VIA WALKWAY LIGHT 230V

Installation manual

Installation instructions

1. Install square wall box (60 mm) or compatible round wall box.
Wall box should have screws with a vertical distance of 60 mm and minimal depth of 35 mm.
2. Connect the 230V lines using the screwless terminals.
3. Fix the via to the wall box with 2 screws using the holes on vertical axis.
4. Mount the cover frame using the clips. Make sure to align the LED with the frame in the correct position.

A Place the frame over the lower clips

B Push the frame upwards, tilt towards the wall and attach the frame over the top clips

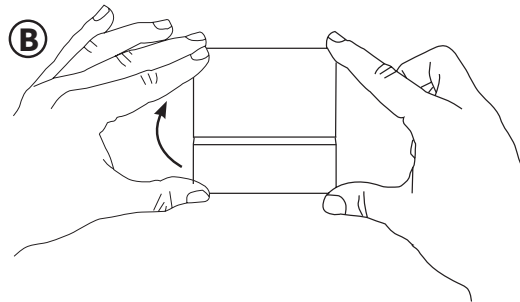
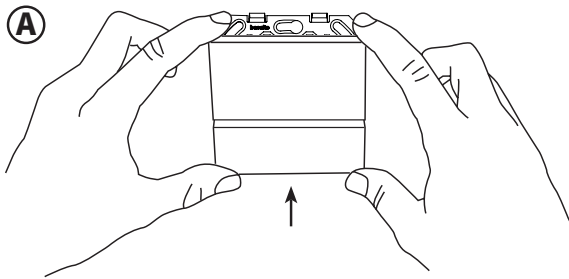

How to remove the Via front cover (see drawing below)

C Push the frame upwards

D Tilt the frame away from the wall

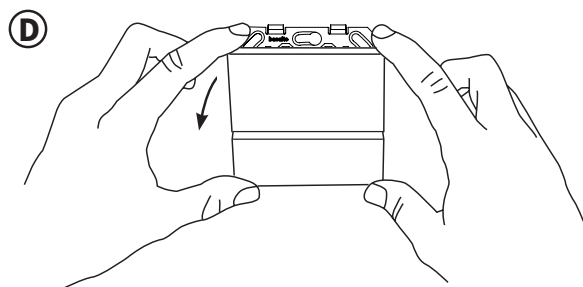
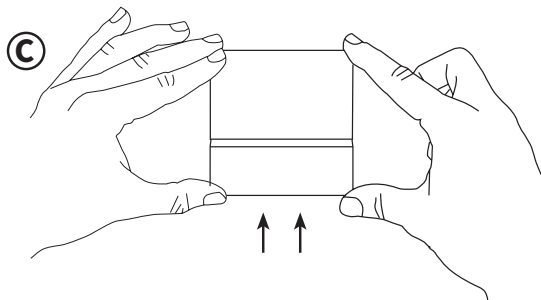

Technical data

Rated voltage: 230 V AC - 50Hz

Non dimmable

Power consumption: 1W

Ambient temperature:

Operation: -5°C to 45°C

Storage: -15°C to 55°C

Transport: -15°C to 55°C

Protection class: I

Type of protection: IP 20

LED color temperature:

0480-11 - cold white - 4000K

0480-12 - warm white - 2700K

(perceived LED color temperature depends on cover finish)